

200 MHz speed High-speed sampling

12-bit resolution High-precision waveform detection



Transforming Motor Winding Testing

NEW

IEC standard-compliant testing

Streamline PDIV and PDEV measurement

Automatically display results simply by setting the starting voltage, maximum voltage, and voltage step width (requires the ST9000 DISCHARGE DETECTION UPGRADE, an option that provides additional functionality).

Increase reliability by measuring rise times

Display rise times for impulse waveforms as defined by standards.

Quantification of response waveforms

Test rotor assembly status

Detect single-turn faults

*Depends on measurement conditions

Improve quality by capturing accumulated turn fault data as feedback for upstream processes

The new standard in winding testing

Detect defects that were impossible to detect in the past



Detect minuscule changes in response waveforms
High-speed sampling × high resolution

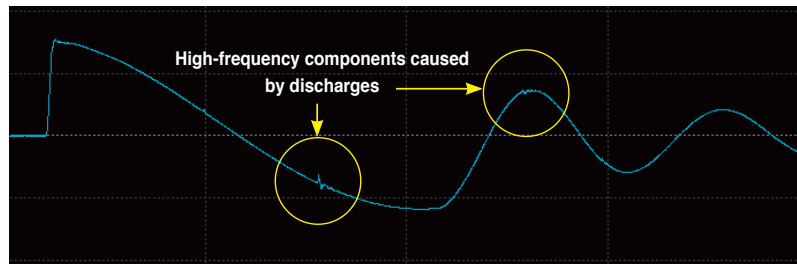

100MHz
Past issue
Difficult to detect instantaneous variations

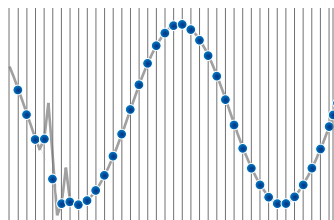

200MHz
ST4030A
Instantaneous variations can be captured at a higher level of detail

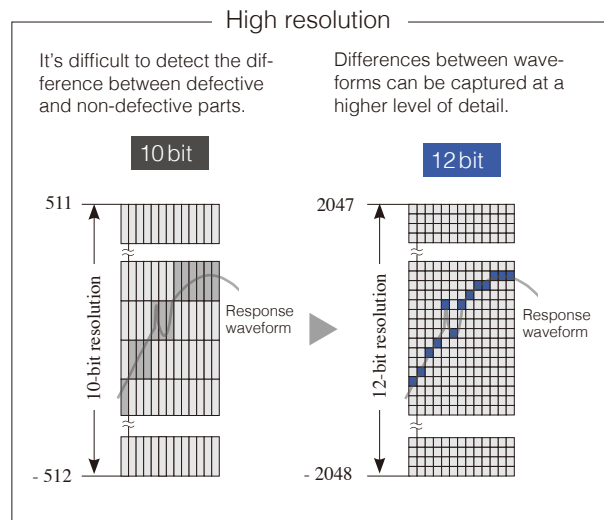
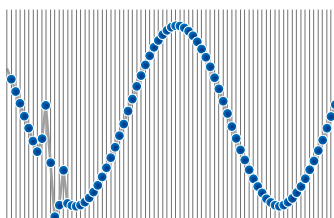



Ample sampling data for proper detection

Capture minuscule variations in response waveforms

However, since the ST4030A supports a large number of sampling points, the instrument can capture waveforms of sufficient length to support detection, even when sampling at 200 MHz.

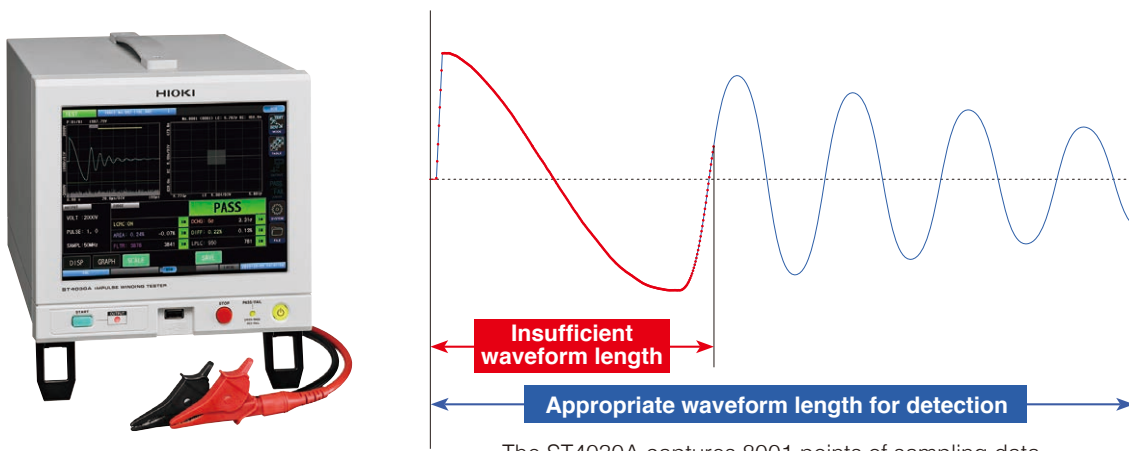

The ST4030A captures 8001 points of sampling data.

Detect single-turn faults

Quantification of response waveforms

Conventional approach

Area comparison based on waveforms

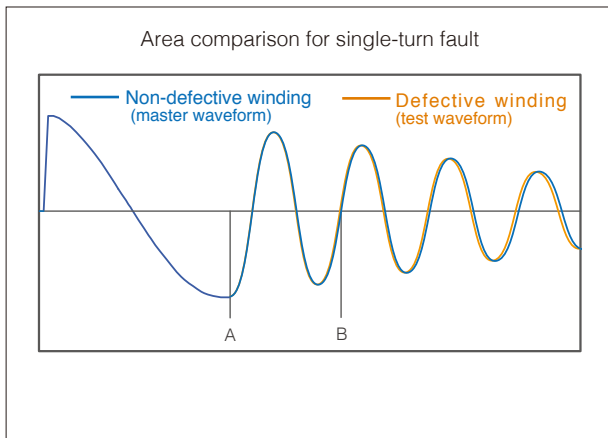

Pass/fail judgments are difficult when area differences do not exceed several percentage points.

Pass/fail judgments are made by calculating the difference in area between the master waveform and the test waveform for the interval specified by the A and B cursors.

New approach

Quantification of response waveforms

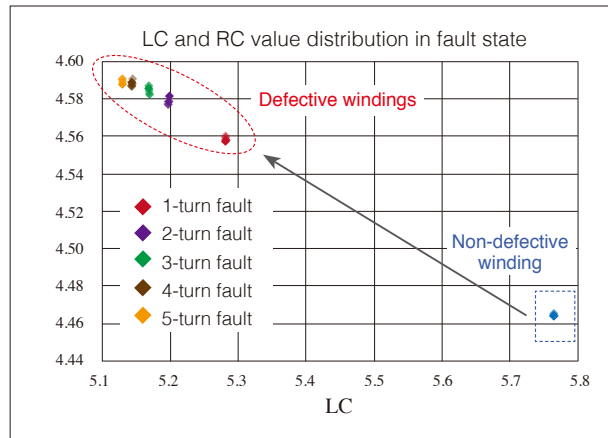

The distributions of values differ for defective and non-defective windings.

The new approach of using LC and RC values makes it possible to detect discrepancies between defective and non-defective windings, including when the differences between waveforms are too minuscule to detect using conventional means*. Since detection thresholds can be clearly defined, the instrument can provide a clear pass/fail decision.

*See "Testable inductance range" in the specifications on the last page for more information about motors for which detection is possible. Performance may depend on conditions. Please consult with your local Hioki distributor for a test demonstration prior to purchase.

Improved applied voltage reproducibility

Detect defective parts with a high degree of repeatability

The ST4030A can detect defective parts with a high degree of precision thanks to low variability in the applied voltage it generates. In addition, differences between instruments when testing the same workpiece are slight, so you can continue to use master workpiece data even after one instrument is swapped out for another.

Applied voltage variability

Conventional instruments

Variability in waveforms makes it difficult to detect shorts.

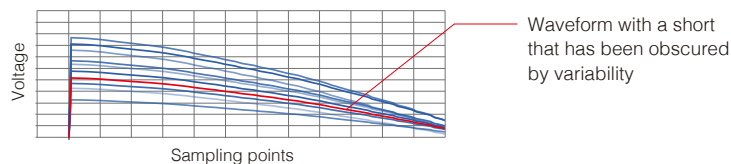

ST4030A

Low waveform variability allows defective windings to be detected with a high degree of precision.

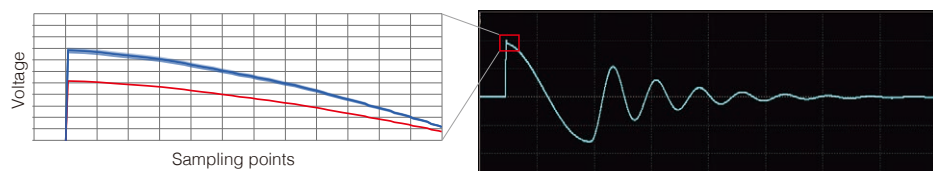

Create a PASS judgment area from the distribution of LC and RC values

Full support to assist in setting testing conditions

Automatic configuration of the PASS judgment area

To make PASS and FAIL judgments, capture master LC and RC values from a known-good master workpiece.

The ST4030A will automatically create a PASS judgment area based on those values.

Choose the shape of the PASS judgment area.

HI-LO Rectangular PASS judgment area

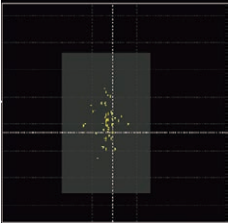

Select when the master workpiece's LC and RC values are distributed in close proximity

FIT Trapezoidal PASS judgment area

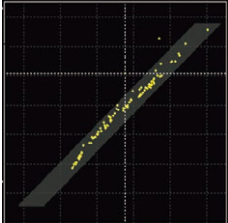

Select when the motor's rotor has been attached and the distribution of the LC and RC values assumes a belt shape according to the rotor position or angle

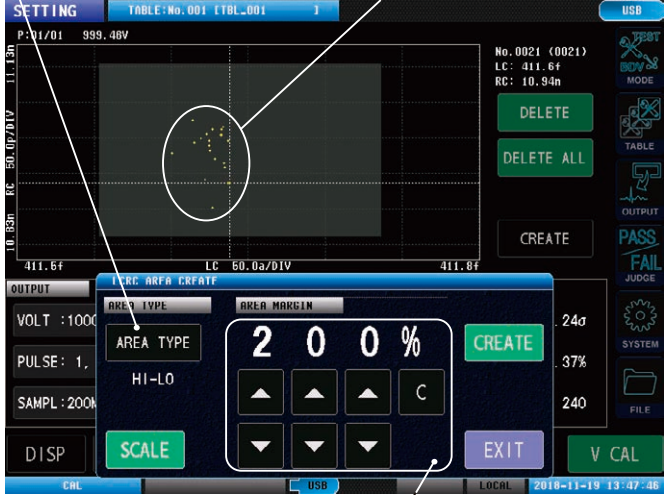

Set the margin

Set the margin to use when the PASS judgment area is automatically created.

CREATE

Automatically create the area by touching this button.

The created PASS judgment area will be shown as a quadrilateral on the LC/RC graph.

Automatic configuration of the waveform capture range

The oscillation frequency of response waveforms varies with the type of workpiece. To allow a sufficient amount of waveform data to be used in LC/RC value calculation and waveform judgment, the sampling frequency and sampling data count are automatically adjusted so as to optimize the waveform capture range.

Workpiece A (low oscillation frequency)

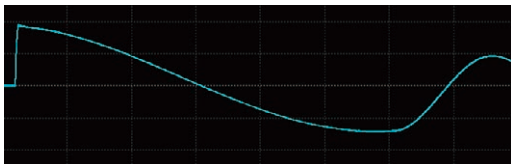

The captured waveform length is inadequate due to the response waveform's low oscillation frequency. The sampling frequency needs to be decreased.

Optimizing the waveform capture range

Workpiece B (high oscillation frequency)

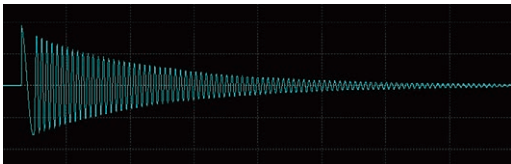

An unnecessary amount of waveforms is being captured due to the response waveform's high oscillation frequency. Either the sampling frequency needs to be increased, or the sampling data count needs to be decreased.

Waveform length after optimization using automatic adjustment

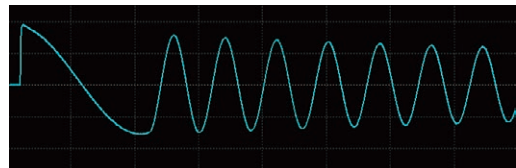

Optional upgrade for the ST4030A

DISCHARGE DETECTION UPGRADE ST9000

Detect pseudo-shorts with a high degree of precision

By detecting minuscule partial discharges that are obscured by noise, the ST9000 makes it possible to detect insulation defects (pseudo-shorts) between motor windings.

Proprietary Hioki filtering process

Of the high-frequency components that appear in response waveforms, noise components that appear throughout the waveform are rejected so that the instrument can extract and make judgments based solely on partial discharge components.

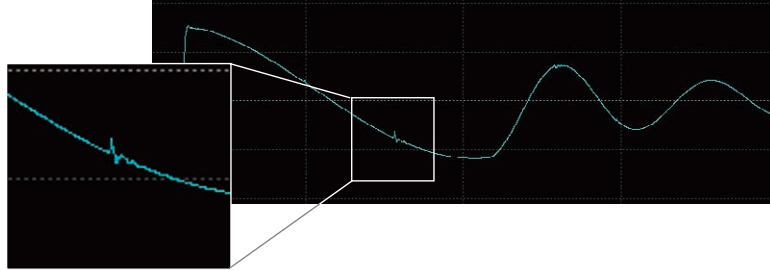

High-precision waveform detection

200 MHz, 12-bit sampling

Isolation of noise components

Proprietary HIOKI filter

Easy discharge detection

No need for peripheral equipment (discharge detection antenna, etc.)

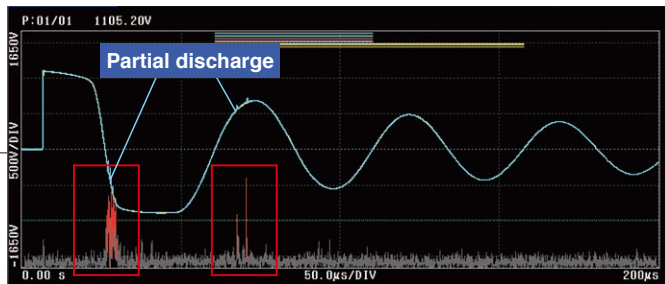

High-frequency discharge components are isolated by a proprietary Hioki filtering process.

NEW RPDIV measurement function

Automate Partial discharge measurement

For instruments equipped with the ST9000 DISCHARGE DETECTION UPGRADE (an option that provides additional functionality)

The instrument can automatically measure the partial discharge inception voltage (PDIV) and partial discharge extinction voltage (PDEV), which are required for partial discharge testing as defined by international standards for motors.

Applied voltage settings that comply with the IEC 61934 test procedure

- START**
(Start voltage)
- TOP**
(Max. voltage)
- STEP**
(Voltage rise width)

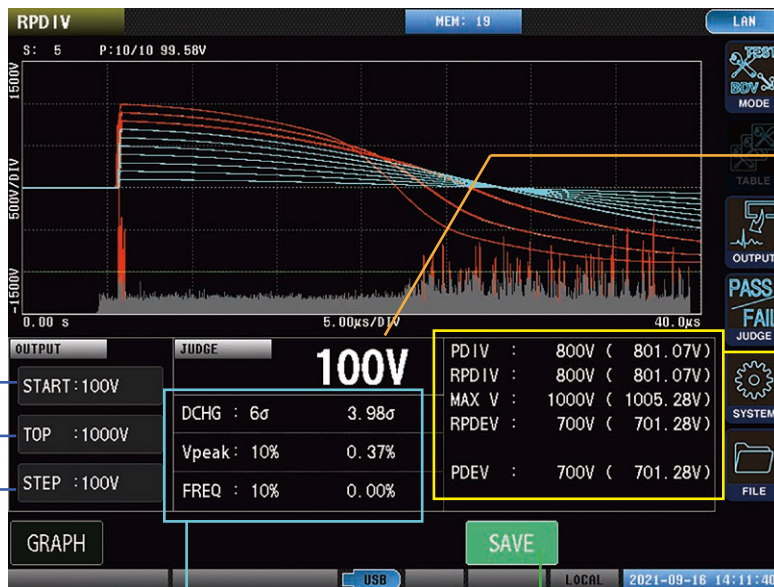

Current applied voltage value

Automatic measurement

Simply set the starting voltage, max. voltage, and voltage rise width to have the instrument automatically perform RPDIV and RPDEV measurement and display the results.

Discharge judgment results

DCHG: Max. deviation of discharge amount
 Vpeak: Max. misalignment width from the standard peak voltage value
 FREQ: Max. misalignment value from the standard vibration frequency

Save function

Test results are saved in the instrument's internal memory. Results can be saved on a USB drive or retrieved using communication commands.

NEW Rise time measurement function

Validate waveform rise time as per IEC standards

Impulse waveform rise times are defined by standards. With the ST4030A, you can choose from four measurement modes and display rise times for review.

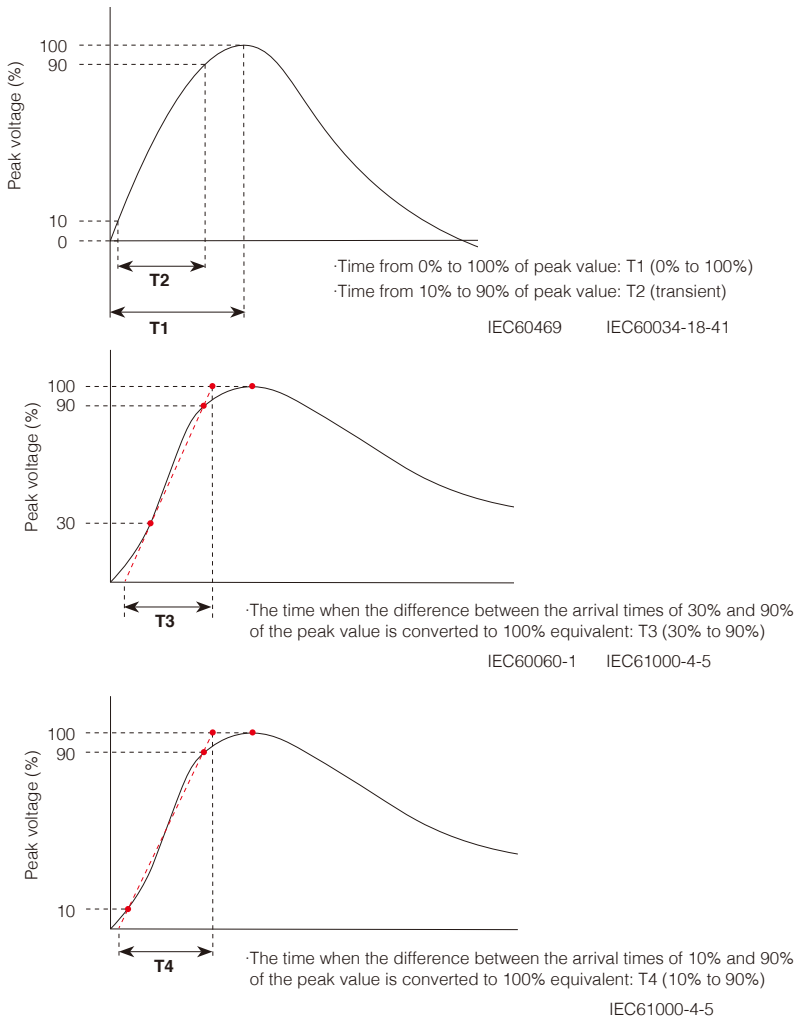

Example rise time displays (with T2 selected)

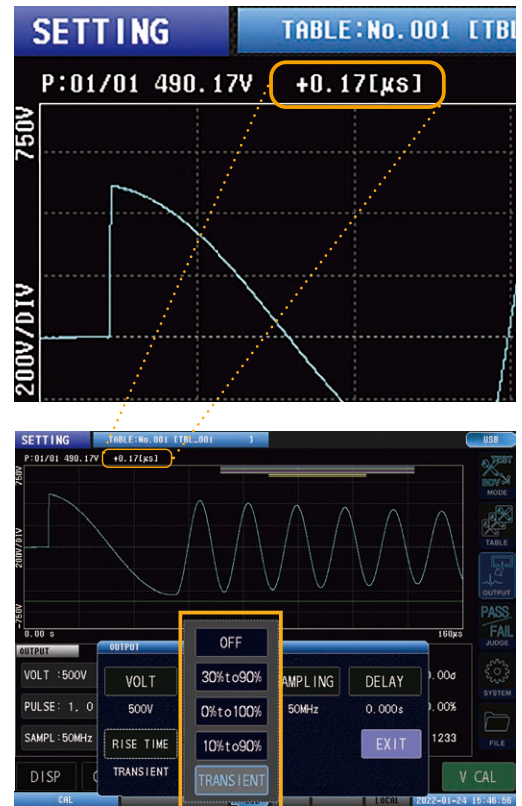

Select from four measurement modes:

- 0% to 100%: T1
- Transient: T2 (default)
- 30% to 90%: T3
- 10% to 90%: T4

NEW

Perform tests using trigger positions based on your objective

Trigger positions that give priority to the part that shows the characteristics unique to the workpiece being tested

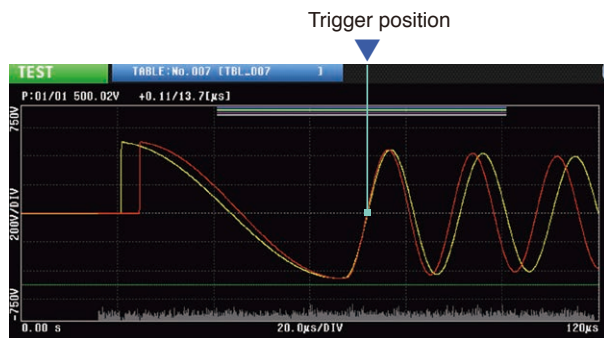

Make judgments based the response waveform using the second waveform, where characteristics unique to the workpiece being tested most readily appear, as the trigger.

Trigger position that priority the entire application waveform

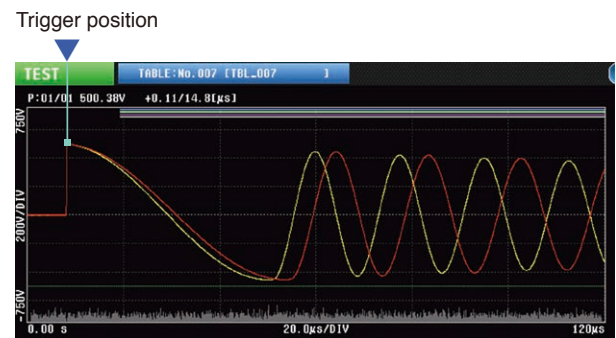

Make judgments based on the response waveform using the rising edge of the application waveform as the trigger (the same approach used by conventional testers).

Caution: Judgments based on LC and RC values are provided as reference values when using this trigger position.

Insulation breakdown voltage testing (**Break Down Voltage**)

The ST4030A also provides functionality for performing insulation breakdown voltage testing, which is required by various standards. An impulse test is performed while the voltage applied to the workpiece is gradually increased, and the insulation breakdown voltage is evaluated based on factors such as the response waveform's LC and RC values, the amount of discharge, and the waveform area.

Stable detection with an extensive range of judgment parameters

- LC and RC values
- Discharge magnitude
- Waveform area comparison
- Peak voltage value
- Oscillation frequency

BDV setting range*

- Setting range: 100 V to 4200 V
- Setting resolution: 10 V
- Number of steps: No limits

*Due to the inductance or capacitance of the DUT, the actual applied voltage may be lower than the set value.

Example PASS judgment

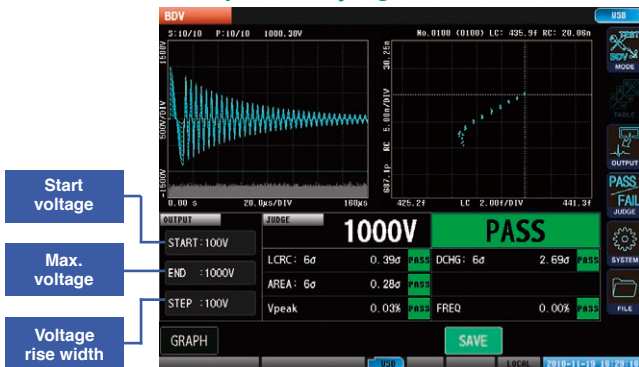

If all judgments yielded a PASS result, testing continues to the maximum voltage.

Example FAIL judgment (discharge FAIL at 2000 V)

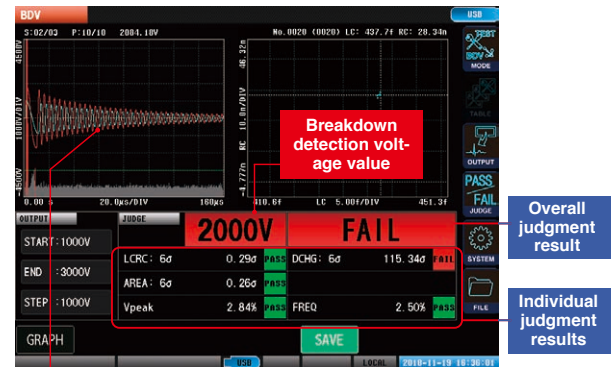

If any of the judgments yields a FAIL result, the insulation is considered to have started to break down, and testing is halted at that point. The breakdown voltage waveform is shown in red.

NEW

Achieve a more fine-grained BDV value measurement

The ST4030A lets you freely set the starting voltage, voltage rise width, and max. voltage without any limits on the number of steps. This capability makes it possible to perform tests with a fine-grained voltage rise width (with a minimum of 10 V steps) for any test voltage range, yielding detailed BDV value measurement results.

No limits on the number of steps (example: 91 steps)

Since there are no limits on the number of steps, even when using a small voltage rise width, you can make measurements right up to the max. voltage to obtain an accurate BDV value. (Up to 32 steps of data can be saved, using thinning as necessary.)

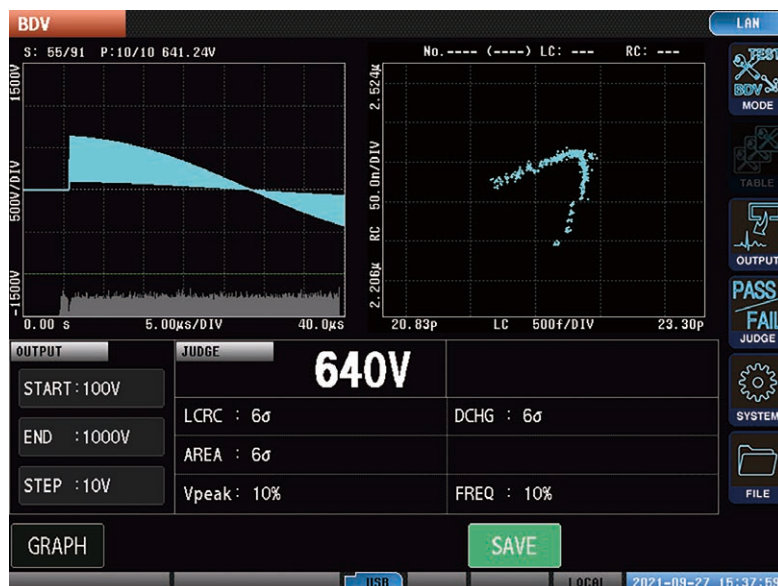

The above screenshot illustrates an example test conducted from 100 V to 1000 V using 10 V steps.

NEW

Streamline impulse durability testing and adjustment work with continuous pulse application

Streamline work by applying a pulse continuously with a single operation so that you can make adjustments while checking changes in the waveform.

Since there's no limit on the number of applied pulses, pulses are output at the specified intervals until testing is stopped.

Number of pulses generated

Real-time monitor
(Display updated using high-speed processing)

In continuous measurement, the display updates for each pulse, allowing the instrument to display impulse waveforms like an oscilloscope.

Enable the overlay function to display overlaid changes to waveforms to check variability.

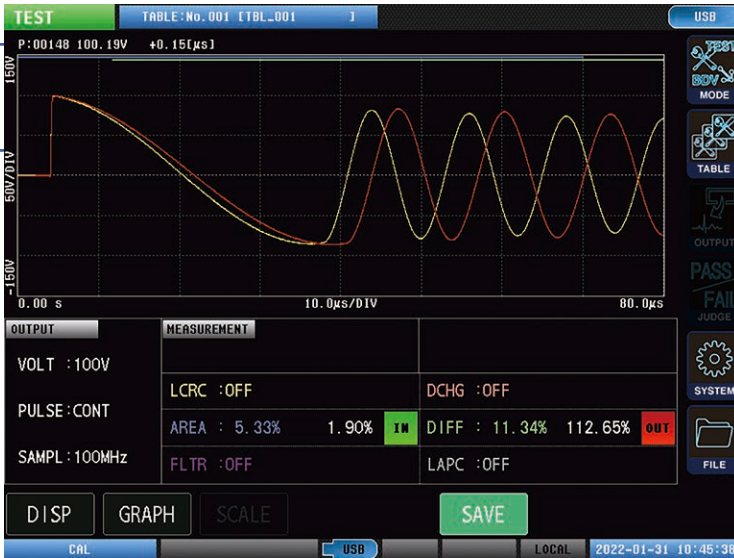

The screenshot shows the instrument's test interface. At the top, it displays 'TEST' and 'TABLE: No. 001 (TBL_001)'. The main display area shows a waveform with a peak voltage of 100.19V and a pulse width of +0.15[μs]. The waveform is a series of pulses that decay over time. Below the waveform, there are several measurement parameters: VOLT: 100V, PULSE: CONT, SAMPL: 100MHz, LCRC: OFF, DCHG: OFF, AREA: 5.33%, 1.90%, DIFF: 11.34%, 112.65%, and FLTR: OFF, LAPC: OFF. The interface also includes buttons for DISP, GRAPH, SCALE, and SAVE, and a status bar at the bottom showing the date and time: 2022-01-31 10:45:38.

During continuous measurement, only measurement data for the most recent pulse is maintained by the ST4030A.

NEW

Compare and display a master waveform and the most recent measured waveform

When the overlay function is disabled, only the master waveform and most recent waveform are displayed, making it easy to view measurement results. (To generate an overlay display of waveform changes, enable the overlay function.)

Overlay display: ON



The screenshot shows the instrument's test interface with the overlay function enabled. The main display area shows two waveforms overlaid: a master waveform (red) and a most recent measurement waveform (blue). The waveform parameters are P: 00023 100.00V +0.14/14.4[μs]. Below the waveform, there are several measurement parameters: LCRC: OFF, DCHG: OFF, AREA: 5.33%, 1.90%, DIFF: 11.34%, 112.65%, and FLTR: OFF, LAPC: OFF. The interface also includes buttons for DISP, GRAPH, SCALE, and SAVE, and a status bar at the bottom showing the date and time: 2021-08-27 10:23:59.

Overlay display: OFF



The screenshot shows the instrument's test interface with the overlay function disabled. The main display area shows two waveforms side-by-side: a master waveform (red) and a most recent measurement waveform (blue). The waveform parameters are P: 00007 100.00V +0.13/13.3[μs]. Below the waveform, there are several measurement parameters: LCRC: OFF, DCHG: OFF, AREA: 5.33%, 1.90%, DIFF: 11.34%, 112.65%, and FLTR: OFF, LAPC: OFF. The interface also includes buttons for DISP, GRAPH, SCALE, and SAVE, and a status bar at the bottom showing the date and time: 2021-08-27 10:22:24.

To observe overlaid measurement results

If waveforms exhibit changes, for example due to the external environment, enable the overlay function so that changes in response waveforms and in LC and RC values are easier to see.

To observe only the master waveform and the most recent measurement waveform

This mode is convenient to make adjustments while comparing waveforms during continuous measurement, for example while assembling stators.

Testing after rotor assembly

Once the rotor has been attached to the motor's stator, the stray capacitance between the rotor and stator will vary depending on the position at which the rotor was attached. This variation in stray capacitance means that the response waveform obtained during impulse testing varies, preventing use of the conventional waveform comparison method.

Although the LC and RC values used to quantify response waveforms also vary due to variations in those waveforms, the distributions of those values vary for defective and non-defective parts. Consequently, impulse testing can be performed after the rotor has been installed as long as defective and non-defective part judgment areas have been created.



Conventional waveform detection

Clear judgment standards cannot be defined due to differences in the response waveforms depending on the position and angle at which the rotor has been attached.

Variations in the voltage waveform when the rotor is rotated (simplified illustration)

Since the waveform varies depending on the locations at which rotor angles A and B occur, it is difficult to determine a standard to use to compare the waveforms.

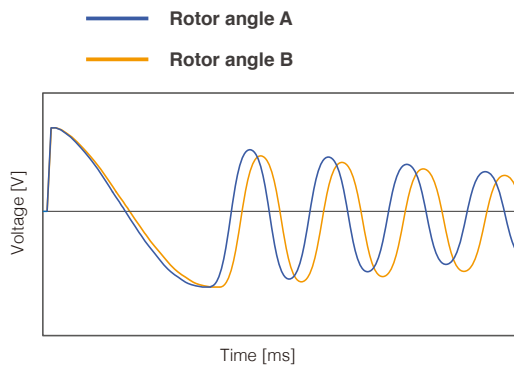

Numerical judgment using LC and RC values

If the non-defective part area is set using healthy phases, impulse testing can be performed following rotor assembly.

Distribution of LC and RC values when the rotor is rotated (at 50 points)

When LC and RC values are sampled while rotating the rotor, the distribution for defective phases differs from the distribution for healthy phases.

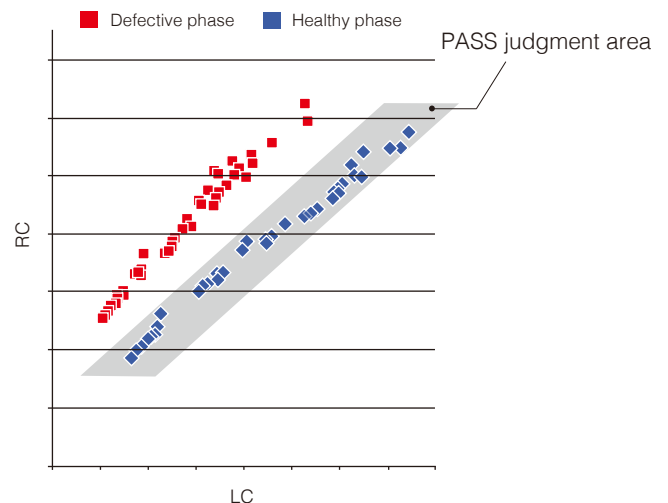

Accommodating differences in response waveform caused by motor characteristics

When testing a motor whose response waveform exhibits reduced resonance due to rotor core loss, the ST4030A automatically adjusts the judgment interval so that evaluations can be made over an interval with high voltage amplitude.

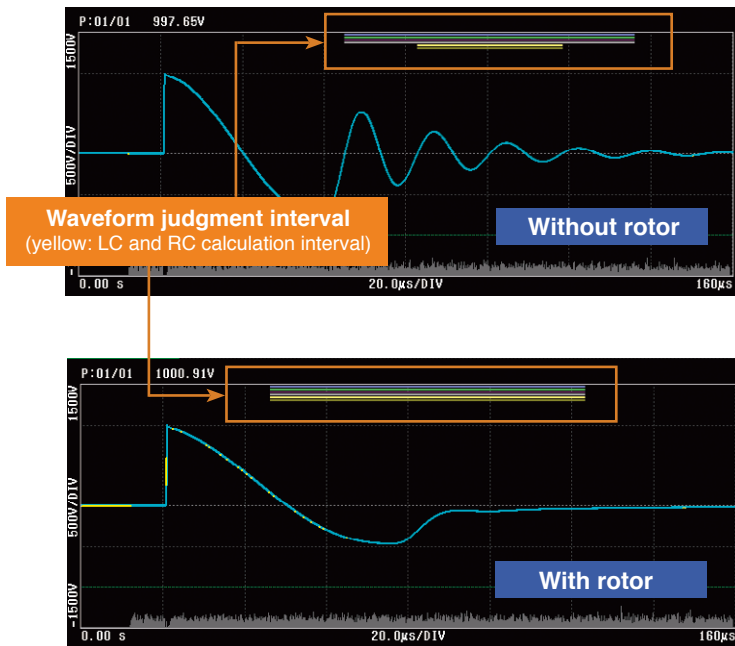

When a rotor is present, the ST4030A reduces the amount of electrical energy supplied to the motor, causing attenuation of the response waveform.

Attenuation of response waveforms

Reductions in electrical energy are primarily the result of the following types of loss:

Core loss

- (1) Hysteresis loss
Loss caused by changes in the orientation of the magnetic molecules in the iron core
- (2) Eddy current loss
Loss caused when an eddy current occurs in the iron core

Output

Conversion of electrical energy into mechanical energy that tries to rotate the rotor

As long as the response waveforms for defective and non-defective motors differ, even if they are attenuated, the motors can be tested.

Improve parts quality by using quantified test results as feedback for upstream processes

Quantitatively manage testing by quantifying response waveforms

Clarify judgment standard values

Clearly determine judgment standards based on numerical data for defective and non-defective workpieces. This information provides a basis for understanding how much the two can differ.

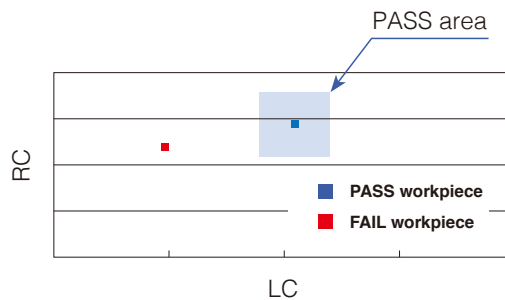

Use test results to manage manufacturing quality

Utilize statistical quality control techniques and accumulate statistical data to estimate when winding defects will occur so as to properly take steps to prevent such issues.

Workpiece	LC [p]	RC [μ]
1	228	4.21
2	227	4.22
3	226	4.22
4	228	4.23
5	227	4.22
6	226	4.21
7	227	4.23
8	225	4.22
9	219	6.51
17	227	4.22
18	228	4.21
19	218	6.52
20	229	4.23

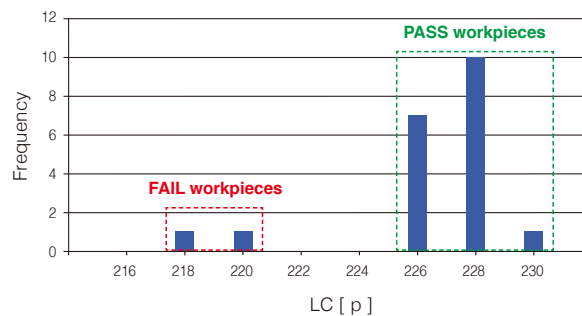

Ideal for embedding in winding inspection systems

Space-saving Half-rack Size

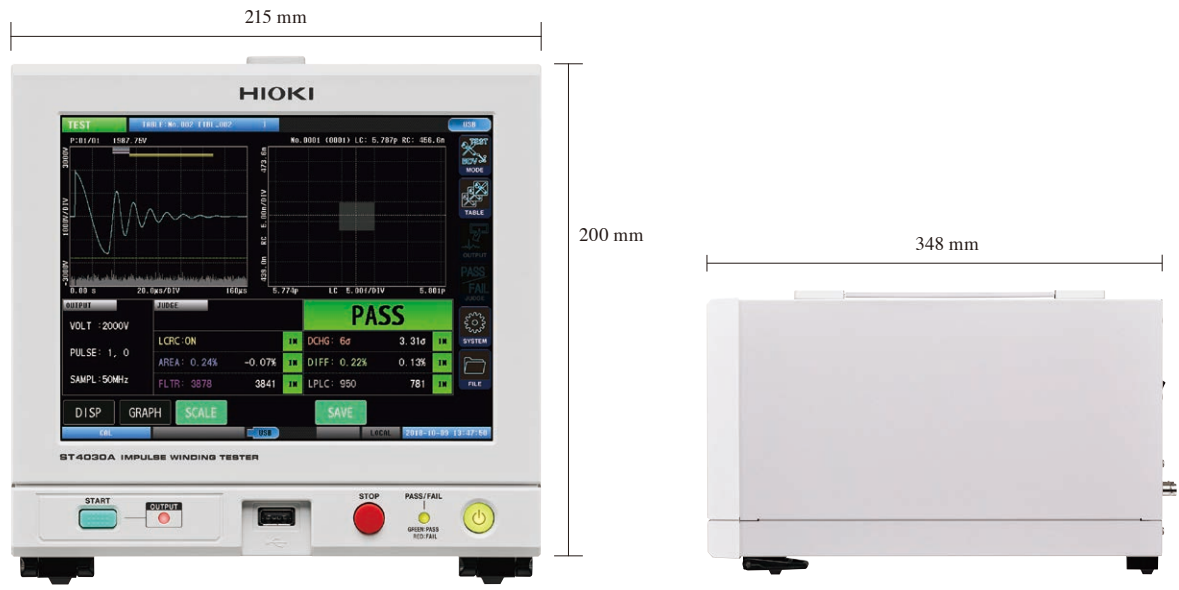

Main unit front

Main unit side

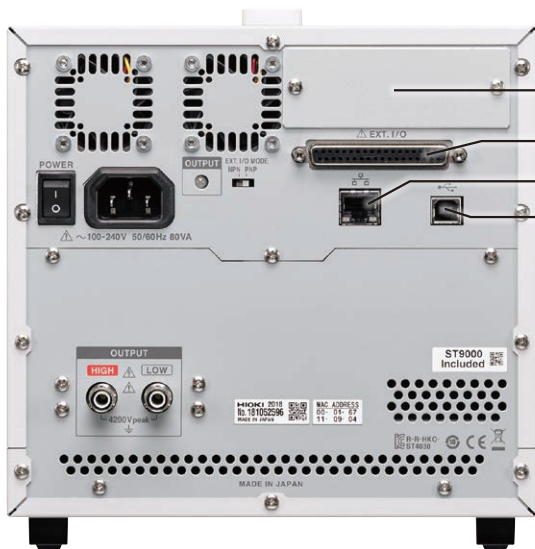

Main unit rear

1. GP-IB
2. RS-232C
3. EXT I/O (Handler interface)
4. LAN
5. USB (for PC connectivity)



GP-IB INTERFACE Z3000



RS-232C INTERFACE Z3001

*The GP-IB and RS-232C interfaces are optional

Extensive range of interfaces

Interfaces

The ST4030A can be controlled from a computer using communications commands sent via its USB, LAN, GP-IB, or RS-232C interface.

LAN

Connector	RJ-45 connector
Electrical specifications	IEEE802.3 compliant
Transmission method	10BASE-T/ 100BASE-TX/ 1000BASE-T Auto detected
Protocol	TCP/IP

GP-IB (optional)

Reference standard	IEEE-488.2
Functional specifications	SH1, AH1, T6, L4, SR1, RL1, PP0, DC1, DT1, C0
Device address	0 to 30

USB (for PC connectivity)

Connector	USB Type B receptacle
Electrical specifications	USB2.0 (Full Speed/High Speed)

RS-232C (optional)

Connector	D-sub 9-pin male connector
Communication method	Full duplex
Synchronization method	Start stop synchronization
Flow control	Software (XON/XOFF control)
Transmission speed	9600, 19200, 38400, 57600 bps

EXT. I/O

The EXT. I/O interface allows you to output signals such as the measurement complete signal (EOM) and the judgment results signal (PASS/FAIL) to an external device and to control the instrument based on input such as a START signal from an external device.

Connectors

Connectors to use (unit side)	D- sub 37-pin
	Female connector with #4-40 inch screws
Compliant connectors	DC-37P-ULR (solder type)
	DCSP-JB37PR (pressure weld type)
	Japan Aviation Electronics Industry, Ltd.

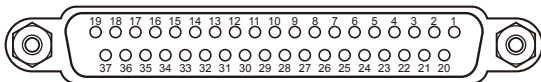

Input signals

Pin	Pin name	Description
1	START	The instrument starts testing at the START signal's ON edge.
20	STOP	The instrument stops testing when it detects the ON edge of the STOP signal during testing.
3	INTERLOCK	If the instrument's interlock setting is enabled, the interlock state is canceled while the INTERLOCK signal is ON.
4 to 7, 22 to 25	TBL0 to 7	Selects the table number in which switchable test conditions have been saved.

Output signals

Pin	Pin name	Description
29	INDEX	Indicates that analog measurement (pulse application and sampling) has ended. When this signal changes from OFF to ON, the probes can be placed in the open state.
28	EOM	This signal is output when testing is complete. The judgment results and ERR signals are refreshed once the EOM signal is output.
10	ERR	This signal is output when a measurement error such as an open error or hardware error occurs.
18	PASS	This signal is output when the overall judgment result is PASS.
37	FAIL	This signal is output when the overall judgment result is FAIL.
11 to 13, 30 to 32	OUT_XXX	These signals are output when a judgment function generates an OUT judgment.
16, 17, 35	OUT0 to 2	These signals can be used as general-purpose output. The output signal can be controlled using the :IO:OUTPut command.

Insulated power source output

Pin	Pin name	NPN/PNP switch settings	
		NPN	PNP
8	ISO_5V	Insulated power source +5 V	Insulated power source -5 V
9, 27	ISO_COM	Insulated power source common	Insulated power source common

Electrical specifications

Input signals	Input type	Photocoupler-isolated non-voltage contact input (with current sink/source output support)
	Input ON	Residual voltage of 1 V or less; input ON current of 4 mA (reference values)
Input OFF	OPEN (breaking current of 100 μA or less)	
Output signals	Output type	Photocoupler-isolated open-drain output (non-polar)
	Maximum load voltage	DC 30 V
	Maximum load current	50 mA/ch
	Residual voltage	1 V or less (load current of 50 mA) / 0.5 V or less (load current of 10 mA)
Internally isolated power supply	Output voltage	Sink output support: +5.0 V ±0.8V; source output support: -5.0 V ±0.8 V
	Maximum output current	100 mA
	Insulation	Floating from protective ground potential and measurement circuit
	Insulation rating	Terminal-to-ground voltage of 50 V DC, 30 V AC rms, 42.4 V AC peak or less

Example of measurement timing

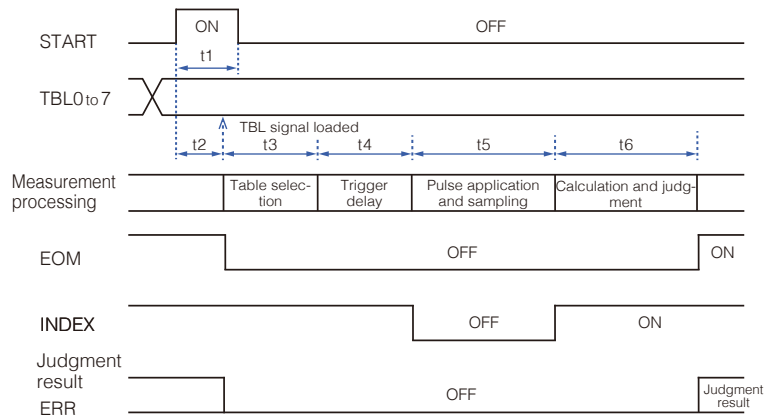

Item	Description	time
t1	START signal ON time	1 ms or greater
t2	Trigger detection time	1 ms (typical value)
t3	Table selection time	10 ms (typical value) *Add the internal discharge time if the test voltage for the table after switching is less than the test voltage before switching.
t4	Trigger delay time	0.000 s to 9.999 s
t5	Analog measurement time	50 ms (typical value for a set voltage of 3000 V, sampling frequency of 200 MHz, and 1 pulse application)
t6	Calculation and judgment time	15 ms (typical value when the AREA, DIFF, FLUTTER, or LAPLACIAN judgment function is enabled) *When applying multiple pulses, indicates the judgment and calculation times for the final pulse.

Test times (reference values)

Measurement times (EOM)	EOM = (INDEX + software processing time + judgment times × number of pulses applied) *Degaussing pulses do not entail software processing time or judgment time. *When applying multiple pulses, the testing process is controlled so that each pulse application interval is not less than the minimum pulse application interval set time.				
Analog measurement times (INDEX)	Time through charging, application, and sampling end (typical value)				
	Set voltage	100 V	1000 V	2000 V	3000 V
	INDEX time	30 ms	30 ms	40 ms	50 ms
Software processing time	Software processing time covering data transfers, etc. (typical value), Processing time: 10 ms *S/s: 200 MHz, DISP: THIN				
Judgment time	Processing time when each judgment function is enabled (typical value)				
	Judgment	Processing time			
	AREA*1	1 ms			
	DIFF*1	1 ms			
	FLTR*1	1 ms			
	LAPC*1	1 ms			
	LC-RC*2	100 ms			
DISCHARGE*3	75 ms				

*1 Judgment area: 1500 pt
*2 Calculation interval: 1500 pt
*3 Judgment interval with sampling speed of 200 MHz: 8000 pt

Specifications (Accuracy guaranteed for 1 year)

Setting voltage	100 V to 4200 V (resolution set in 10 V steps, max. Maximum applied energy: approx. 88 mJ)*	
Testable inductance range	10 μ H to 100 mH	
Sampling speed	200 MHz / 100 MHz / 50 MHz / 20 MHz / 10 MHz	
Sampling resolution	12 bit	
Voltage detection accuracy	DC accuracy: $\pm 5\%$ of setting, AC band: 100 kHz, ± 1 dB Accuracy guarantee conditions: 23°C $\pm 5^\circ$ C, 80% RH or less	
Number of samples	1001 to 8001 points (set in 1000 point steps)	
Judgment method	The same impulse voltage is applied to a master workpiece and the workpiece under test, and a PASS/FAIL judgment is made by comparing the shapes, LC and RC values, and discharge component magnitudes of the respective response waveforms.	
	LC/RC value judgment	LC/RC value judgment (LCRC AREA)
	Waveform judgment	Waveform area comparison judgment (AREA) Waveform differential area comparison judgment (DIFF-AREA) Waveform flutter detection judgment (FLUTTER) Waveform second derivative detection judgment (LAPLACIAN)
	Discharge detection (With ST9000)	Discharge detection (DISCHARGE)
	Others (BDV mode only)	Max. misalignment width from standard of the peak voltage value(Vpeak) Max. misalignment width from standard of the vibration frequency(FREQ)
Insulation breakdown voltage testing (BDV)mode	The workpiece is subjected to impulse testing while gradually raising the applied voltage to determine the voltage at which the insulation breaks down. Waveform area judgment, discharge judgment, and LC/RC value judgment are used to judge insulation breakdown.	
	Setting items	START (Start voltage), END (Max. voltage), STEP (Voltage rise width)
Discharge starting voltage testing (RPDIV) mode (with ST9000 Discharge Detection Upgrade)	Checks for discharge generation by performing impulse testing through applying voltages in accordance with the procedure defined by IEC 61934.	
	Setting items	START (Start voltage), TOP (Max. voltage), STEP (Voltage rise width)
	Measurement items	PDIV, RPDIV, MAX V, RPDEV, PDEV
Number of test condition tables	255 (test condition settings, detection condition settings, master waveforms)	
Test duration	Approx. 60 ms (reference value when tester is configured for 3000 V, 1 pulse, detection off)	
Display	Touch screen display: 8.4-inch SVGA color TFT LCD (800 \times 600 dots) Functionality for changing the background color: 4 colors available	
Safety functionality	Key lock, interlock, double-action design (to prevent erroneous operation when starting testing)	
Other functions	Rise time measurement function (Compliant with IEC 60469, IEC 60034-18-41, IEC 60060-1, and IEC 61000-4-5)	OFF / 30% to 90% / 0% to 100% / 10% to 90% / TRANSIENT
	Trigger position	AUTO / MINUS / FALL / RISE
	Overlay display	OFF / ON
	Continuous pulse application	OFF / ON

*The actual applied voltage may be lower than the set value depending on the inductance or capacitance of the DUT.

General specifications

Operating environment	Use indoors at an elevation of 2,000 m or less in an environment with a maximum pollution level of 2
Operating temperature and humidity range	0°C to 40°C (32°F to 104°F), 80% RH or less (no condensation)
Storage temperature and humidity	-10°C to 50°C (14°F to 122°F), 80% RH or less (no condensation)
Standards compliance	Safety: EN 61010, EMC: EN 61326 Class A
Power supply	AC100 V to 240V, 50 Hz/60 Hz
External interface	Standard equipment: EXT. I/O, USB host (memory stick), USB device (for communications), LAN Options: RS-232C (Z3001), GP-IB (Z3000)
Dimensions	Approx. 215 mm (8.46 in) W \times 200 mm (7.87 in) H \times 348 mm (13.7 in) D (excluding protrusions)
Mass	Approx. 6.7 kg (236.3 oz)
Accessories	Power cord, instruction manual, application disc, operating precautions

Model: IMPULSE WINDING TESTER ST4030A

Model No. (Order Code)
ST4030A

Additional function options

DISCHARGE DETECTION UPGRADE ST9000

Model No. (Order Code)	
IM9000	Factory option
IM9000-01*	Downloadable (license card)
IM9000-03*	Downloadable (digital license)

*Software provided via GENNECT download portal

The Discharge Detection Upgrade ST9000 is available as an optional function for the Impulse Winding Tester ST4030A. This function is not included with the ST4030A as standard and must be purchased separately as a firmware upgrade.

Options

CLIP TYPE LEAD L2250

Maximum rated voltage: 3300 V AC peak,
1.5 m (4.92 ft) length



UNPROCESSED LEAD CABLE L2252

Maximum rated voltage: 4200 V AC peak,
2 m (6.56 ft) length



GP-IB INTERFACE Z3000



GP-IB CONNECTOR CABLE 9151-02
2 m (6.56 ft) length



Caution: Effect of cable parasitic components

The oscillation waveform varies with the length of the cable. Please contact your Hioki distributor concerning availability of special-order cables whose capacitance values fall within the acceptable range.

RS-232C INTERFACE Z3001



RS-232C CONNECTOR CABLE 9637
9 pin - 9 pin, cross, 1.8 m (5.91 ft) length



Maximum applicable voltage to the DUT (reference value)*

*The maximum applicable voltage may vary depending on the characteristics or losses of the DUT (Device Under Test). Please be sure to verify in advance whether the test voltage can be applied to the DUT.

First Peak Voltage on Low-Loss Coil Under Impulse Voltage

First peak voltage when the discharge terminal voltage is 4200 V

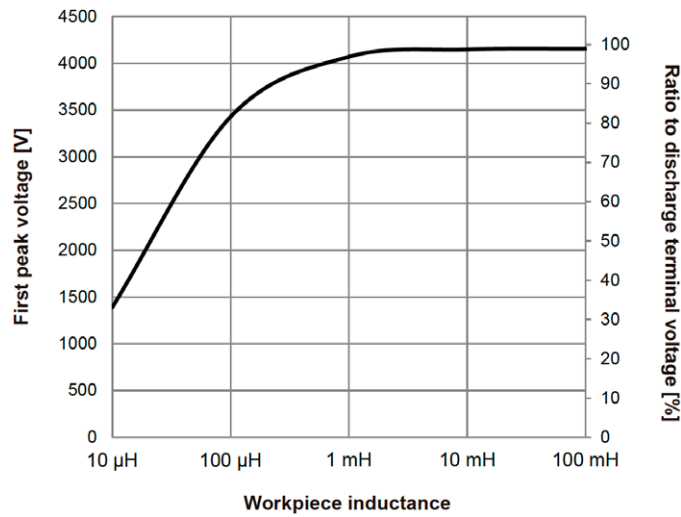

First Peak Voltage on Low-Loss Coil Under Impulse Voltage

Maximum voltage when the discharge terminal voltage is 4200 V

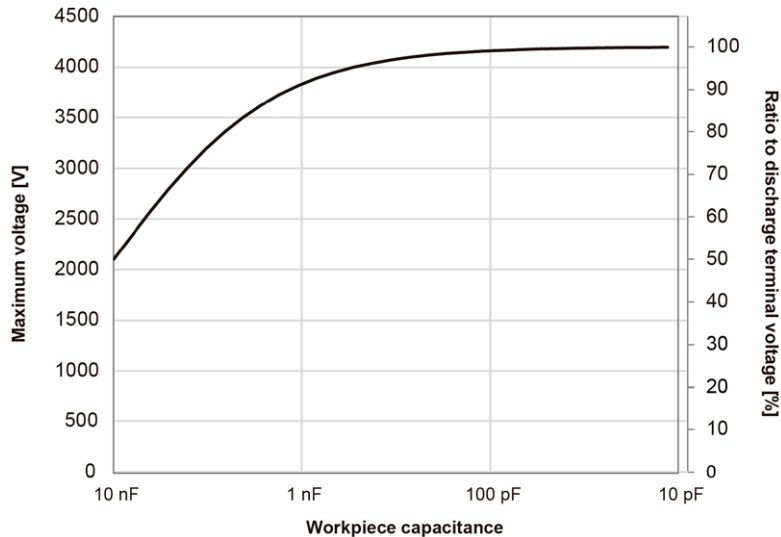

Applications

Partial Discharge Testing of Motor Stators with an Impulse Tester

It's possible to check for insulation defects in motor stators by observing current waveforms during impulse voltage application.

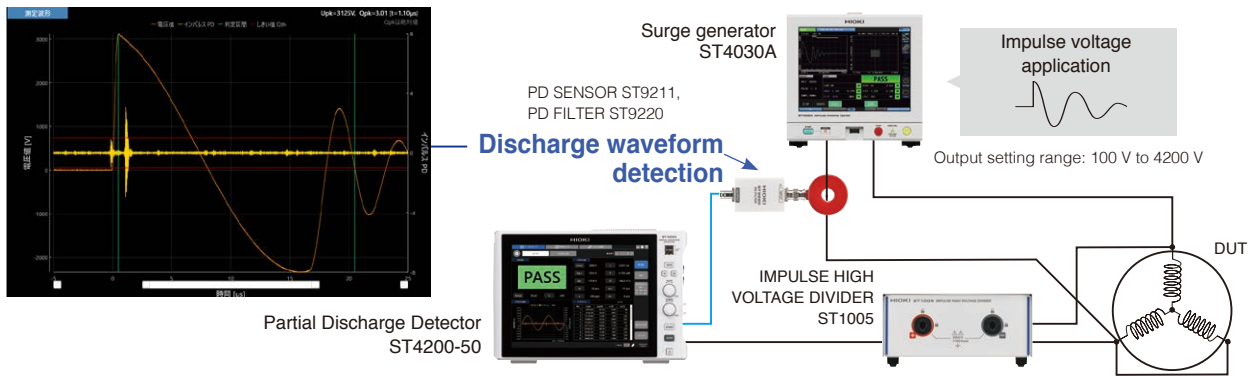

Automatic impulse testing of motor stators using high-voltage relays

In the case of a 3-phase stator, impulse tests are carried out between each phase combination: U-V, V-W, W-U, V-U, W-V, and U-W.

Consequently, manufacturers work to automate such tests by using relays to switch test circuits.

However, when test voltages exceed 1500 V, it becomes impossible to use standard relays.

As a result, impulse testing between stator phases is carried out by means of manual measurement or manual switches.

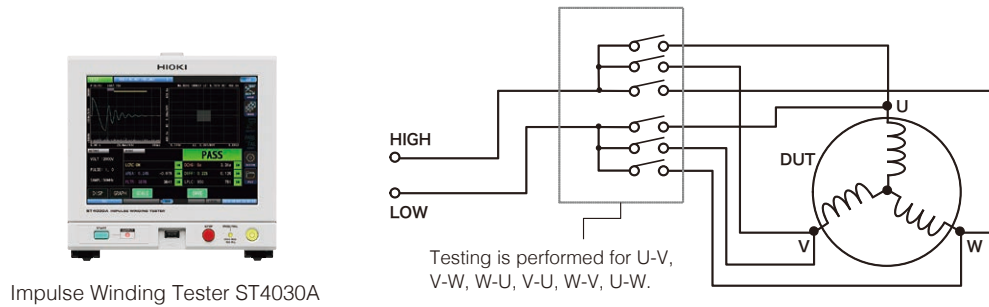

Automate testing using a setup such as the one shown below by using a High Voltage Scanner 3930 to switch the measurement circuit.

*Separate purchase required.

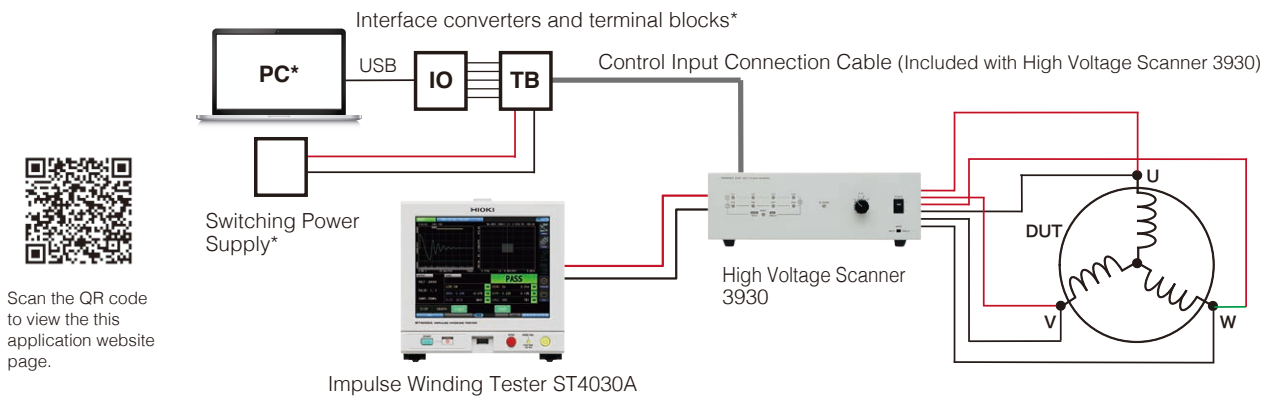

Scan the QR code to view the this application website page.

Note: Company names and product names appearing in this catalog are trademarks or registered trademarks of various companies.

HIOKI
HIOKI E. E. CORPORATION

DISTRIBUTED BY

HEADQUARTERS
81 Koizumi,
Ueda, Nagano 386-1192 Japan
<https://www.hioki.com/>

Scan for all regional contact information