



EDGE-3

Soundproof Micro Data Center



We engineer for a sustainable tomorrow.

Contents

| | |
|---|------|
| Why edge compute? | 2 |
| Rapid deployment MDC | 3 |
| Features and benefits | 4-5 |
| Specification, dimensions and performance | 6 |
| Dimensional Drawings | 7 |
| EDGE Management System EMS | 8 |
| EDGE Accessories | 9-11 |

Why edge compute?

In our digital age more devices are connected to the internet utilising cloud based storage. The number of devices and users continue to increase which puts a strain on bandwidth causing latency.

This can be done in an environment other than a traditional data room thereby saving real estate and comms/data room build expense.

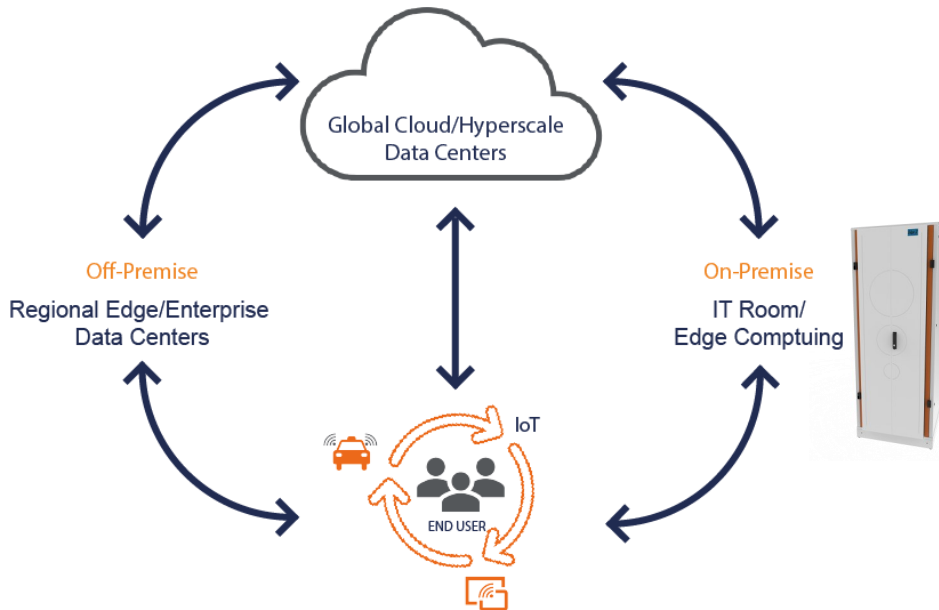

The reduction in user bandwidth availability and the increase in latency could have dire consequences depending upon the application being used.

USystems offer a broad range of self contained intelligent modular systems called *EDGE* to house localised computing, which can be deployed directly into factories, warehouses, offices, M2M, multiple users, businesses etc., either as a standalone cabinet or bayed together in a dedicated room.

This latency and decrease in bandwidth can be overcome by introducing on-premise edge computing. This allows the user to access immediate computer power locally whilst using the cloud simply to store information.

Rapid deployment Micro Data Centre

The EDGE-3 soundproof MDC is an exceptional range of enclosures with a combination of noise reduction and air-cooled thermal performance. The EDGE-3 is a superior alternative to a costly data and communications room, by allowing the deployment of servers and network equipment directly in the office and requires less than 1m² of valuable floor space. It allows for localized on premise computing in populated or more sensitive locations – especially where there might be a concern of server noise being a distraction or breaching ECC working noise guidelines.

The EDGE-3 will reduce equipment noise up to 28.5dBA (99.9%) of IT noise, while providing a thermal load capacity of 11.5kW.

The EDGE-3 is an excellent all round 19" data, comms and server cabinet, with adjustable front and rear mounting angles and 6 cable entry ports. Reducing energy bills is always desirable but expecting a standard server cabinet to assist in this aspect is virtually impossible. That is where the EDGE-3 is uniquely different in design, the two EC fans located in the rear doors maintain sufficient airflow throughout the enclosure, providing the required level of thermal dissipation, while optimizing the level of 'ambient' background noise the cabinet itself generates

and minimizing power expenditure. To ensure maximum energy efficiency, it is controlled with variable fan speed controls and temperature sensors.

Peace of mind is provided by an onboard environmental and optional security monitoring system. Real time alarms and alerts, which can be viewed via the WebUI, will notify authorized personnel via email alarms relating to any issues with the cabinet. Meaning you know what's going on and can monitor who's coming and going 24/7. Advanced configurations are available for enhanced levels of security and redundancy.

The LCD touch display on the cabinet doors will change colour if the cabinet status changes, alerts (amber) or alarm (red). It will remain blue when working correctly. Touching the display will show environmental data from each temperature/humidity sensors or in the event of an alarm what that alarm specifically is.

Simple 'plug and play' EDGE-3 solution is supplied pre-configured from the factory with built in intelligence and an energy efficient air-cooling system for effortless installation and customer convenience.

7 Reasons to Buy

1. Cost-Effective & Green - server rooms are costly to build and run whereas EDGE-3 offer a fraction of the running costs and minimal initial investment
2. Cool - innovative air-flow design for effective thermal dissipation of 11.5kW
3. Soundproof - reduce equipment noise up to 28.5dBA (99.9%) of IT noise
4. Lockable - security features keep your equipment safe
5. Easy to Deploy - just plug and go
6. Expandable – when you need extra capacity, just add another EDGE-3
7. Portable - easily relocated to another room or building

Typical application spaces:

- Staffed offices
- IT/comms rooms
- Studios
- Libraries
- Laboratories
- Receptions
- Surgeries
- Hospital wards
- Showrooms
- Classrooms
- Home offices

For safe running we recommend siting in a ventilated space, typically at 70°F/21°C and below but not warmer than 80.5°F/27°C

A sound investment!

Deploying active IT equipment into the middle of a working environment can be off-putting for visitors and detrimental to working conditions in terms of the constant evasive noise and excessive heat generated from the active equipment.

The *EDGE-3* effortlessly removes these issues and stylishly blends into the working environment. The 42U cabinet effectively removes up to 28.5dBA (99.9%) of IT noise, which is tech speak for saying that it will reduce server noise down to a whisper.

Features and benefits



EC fan technology

Energy saving and hot swappable



LCD display

Displaying alarm state and major monitoring points



Swing handle and two point locking

*Providing high security—
electronic upgrade available*



Foam cable entry system

Speedy installation without compromise to performance

Dynamic load
750kg Static load
1500kg



Plinth corners, heavy duty castors and levelling feet

For safe rapid deployment



IP54 Upgrade option

IP44 as standard for protection from dust ingress



Door dust filters (optional upgrade)

Providing a dust free

Features and benefits cont.



EDGE Management System EMS
Providing real time environmental monitoring



Anti air-recirculation kit
Save energy and maintain hardware performance

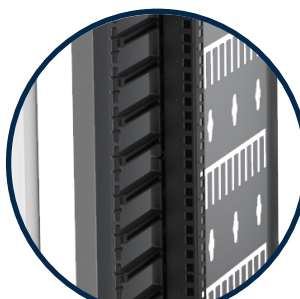

Cable management fingers (optional upgrade)
Ideal for tidy cabling and

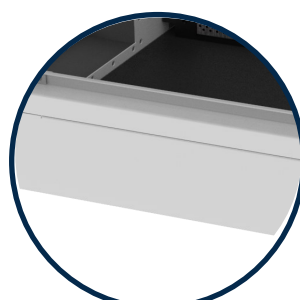

Plinth panels
For that finishing touch



Cable tray (optional upgrade)
Ensure best cabling practice



ETL listed
Proof of product compliance to published industry standards



Security Camera (optional upgrade)

Captures video and images automatically when the door opens

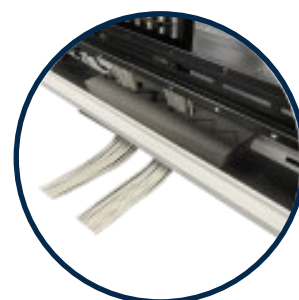

Cable entry
Generous access with three entries at the top and three at the bottom of the cabinet

Technical Specification

| General | | Edge 3 12U | Edge 3 24U | Edge 3 42U |
|--|---------------------|---|----------------------------|----------------------------|
| Order Code — 100 to 115v | Light Grey Black | E3G-1211-15 E3B-1211-15 | E3G-2411-15 E3B-2411-15 | E3G-4211-15 E3B-4211-15 |
| Order Code — 200 to 240v | Light Grey Black | E3G-1211-24 E3B-1211-24 | E3G-2411-24 E3B-2411-24 | E3G-4211-24 E3B-4211-24 |
| H x W x D | mm | 720 x 780 x 1100 | 1154 x 780 x 1100 | 2054 x 780 x 1100 |
| Weight (Cabinet) | kg/lbs | 140 /308 | 204/449 | 328/723 |
| Weight (300mm Extension Frame) | kg/lbs | 23/51 | 33/73 | 47/104 |
| Dynamic load *inclusive of cabinet weight | kg/lbs | 750/1653 | | |
| Static load *inclusive of cabinet weight | kg/lbs | 1500/3307 | | |
| Index of Protection | | IP44 - Upgrade to IP54 available | | |
| Noise reduction of IT noise | dBA | 28.5dBA (99%) | | |
| Paint finish | Light Grey Black | Semi Gloss powder coat - Light Grey RAL 7035 and Orange RAL 2009 Semi Gloss powder coat - Black RAL 9005 and Orange RAL 2009 | | |
| Frame material | mm | 1.5mm CR4 steel | | |
| Passive and active doors material | mm | 1.0mm, 1.2 & 2.0 mm CR4 steel | | |
| Top Cover material | mm | 1.2mm CR4 steel | | |
| Mounting angles material | mm | 2.0mm CR4 steel | | |
| Foam | mm | Fire Retardant | | |
| Intelligence | | | | |
| Monitoring Function | | On touch | | |
| Touch Screen LCD display | | Colour Alarm - Shows temperature & humidity, contact sensors | | |
| EC Fan Control | | Up to 2 - 2 set fan curves and custom option | | |
| Temp + Humidity | | Up to 4 sensors | | |
| Door Status | | Up to 6 dry contacts | | |
| Alarming | | SMTP & LCD Display alarms | | |
| Reporting | | Local reporting - Alarms Fan Speed Temperature and Humidity Contact sensor Camera | | |
| Alerts | | Notify when service or filter is due | | |
| Connectivity | | SNMP V1 , V2 & V3 out | | |
| Cooling Capacity | | Edge 3 12U | Edge 3 24U | Edge 3 42U |
| Max. Thermal Load | kW | 12 | 12 | 12 |
| Fan Type | | Backward curve EC Fan | | |
| Cooling Type | | Air Cooled | | |
| Air cooling capacity 230V | kW | 6.2 | 10.5 | 11.5 |
| Air cooling capacity 115V | kW | 6 | 9 | 10 |

Drawings

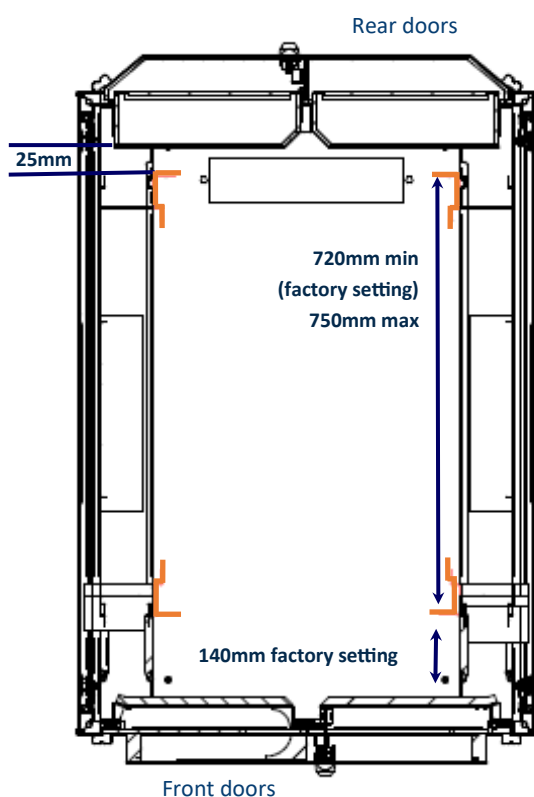

Standard footprint internal dimensions

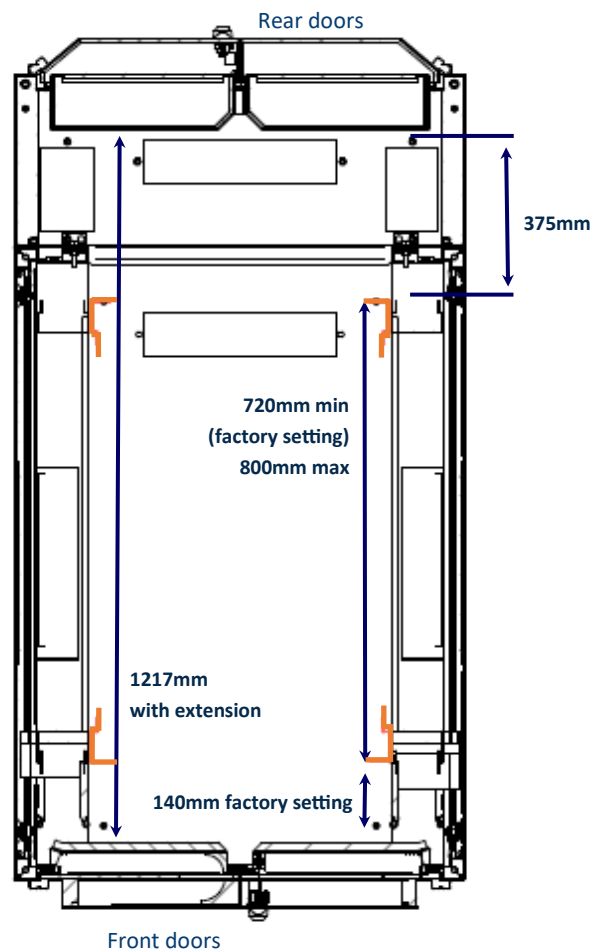

Internal dimensions with 300mm extension

Materials and finish

Frame , cladding and accessories

1.2, 1.5mm, 2.0mm & 3mm CR4 steel

Fans x 2

115v or 240v EC fan

Intelligence

EDGE Management System

Earth bonding kit

4mm diameter earth cable

Polyolefin film

NG25-0.1mm

Soundproof foam

DST0880 – density 26 to 32 kgm-3

Gasket

Fire retardant

Dust filter

Reticulated foam

Cable entry system

Fire retardant foam

Fixed plinth, HD castors and levelling feet

750kg dynamic load, 1500kg static load

Semi gloss powder coat

Light grey
RAL 7035

Orange
RAL 2009

*Dynamic Load Rating is the total rolling mass of the rack and includes the rack frame, cladding and any fitted equipment and accessories and is subject to the load being evenly distributed at 20U height and below. Dynamic load relates to the movement of a rack within the same data centre on a smooth floor clear of any obstacles. Not suitable for transportation on a vehicle when loaded to this weight.

Compliance statement: Manufactured to IEC 602973 and EIA STD 310 for panels and racks housing electronic equipment

EDGE Management System 'EMS'

Providing complete peace of mind

A standard feature of the EDGE-3 is the inclusion of the Edge Management System EMS controlling the 2x EC Fans and the environmental status of the cabinet with up to 4 temperature and humidity reporting and alarming if over threshold is reached.

Additional contact sensors to notify of door access. Displayed on a easy to view Webui with SNMP trap send, V1, 2 and 3 available to send out data and alarms.

Because you need to know

Whilst it is the EMS which takes care of the energy efficient cooling, it is also the EMS which brings together the whole solution. Alarms and alerts in real time will notify you of any issues with your cabinet. The LCD screen on the cabinet will also show an alarm status, touch will provide sensor data, fan status and contact sensor triggers.

Takes up 1 U Space, saving valuable rack space



Front View



Front View



Rear View



Accessories

| Option | | Edge 3 12U | Edge 3 24U | Edge 3 42U |
|--|---------------------|------------------------------|------------------------------|------------------------------|
| 300mm Deep Server Extension Kit (Factory Fitted) | Light Grey Black | E3G-12-EX-AF E3B-12-EX-AF | E3G-24-EX-AF E3B-24-EX-AF | E3G-42-EX-AF E3B-42-EX-AF |
| 300mm Deep Server Extension Kit (Packaged Accessory) | Light Grey Black | E3G-12-EX-AA E3B-12-EX-AA | E3G-24-EX-AA E3B-24-EX-AA | E3G-42-EX-AA E3B-42-EX-AA |
| IP54 Upgrade Kit (Factory Fitted) | | E3X-12-IP-AF | E3X-24-IP-AF | E3X-42-IP-AF |
| IP54 Upgrade Kit (Packaged Accessory) | | E3X-12-IP-AA | E3X-24-IP-AA | E3X-42-IP-AA |
| Top Ducting Exhaust System (Factory Fitted) | Light Grey Black | N/A | E3G-DS-AF E3B-DS-AF | |
| Top Ducting Exhaust System (Packaged Accessory) | Light Grey Black | N/A | E3G-DS-AA E3B-DS-AA | |
| Cisco Side Venting Kit (Factory Fitted) * | Black | E3B-12-CK-AF | E3B-24-CK-AF | E3B-42-CK-AF |
| Cisco Side Venting Kit (Packaged Accessory) * | Black | E3B-12-CK-AA | E3B-24-CK-AA | E3B-42-CK-AA |
| 75w Cable Tray (Factory Fitted) | Black | E3B-1275-CT-AF | E3B-2475-CT-AF | E3B-4275-CT-AF |
| 75w Cable Tray (Packaged Accessory) | Black | E3B-1275-CT-AA | E3B-2475-CT-AA | E3B-4275-CT-AA |
| 300w Cable Tray (Factory Fitted) | Black | E3B-1230-CT-AF | E3B-2430-CT-AF | E3B-4230-CT-AF |
| 300w Cable Tray (Packaged Accessory) | Black | E3B-1230-CT-AA | E3B-2430-CT-AA | E3B-4230-CT-AA |
| Cable Management Fingers (Pair) (Factory Fitted) * | Black | E3B-12-CM-AF | E3B-24-CM-AF | E3B-42-CM-AF |
| Cable Management Fingers (Pair) (Packaged Accessory) * | Black | E3B-12-CM-AA | E3B-24-CM-AA | E3B-42-CM-AA |
| Passive Filter Replacement Kit (Pair) (Packaged Accessory) | | E3X-12-PF-AA | E3X-24-PF-AA | E3X-42-PF-AA |
| Active Filter Replacement Kit (Pair) (Packaged Accessory) | | E3X-AF-AA | | |
| Camera Security Kit (Factory Fitted) | | E3X-CS-AF | | |
| Camera Security Kit (Packaged Accessory) | | E3X-CS-AA | | |
| Temperature and Humidity Sensor (Packaged Accessory) | | EXX-TH-AA | | |
| Contact Sensor (Packaged Accessory) | | EXX-CO-AA | | |
| Foam Cable Entry Block (Packaged Accessory) | | EXX-CE-AA | | |

EDGE Accessories

EDGE Air ducting kit option

Best practice energy saving option

The *EDGE* air ducting kit offers massive cost savings by reducing the need for ambient air conditioning and heating.

It enables hot exhaust air to be directed outside the room or building, **saves on energy** and keeps the room cool and protects the ambient temperature.



- Save money, energy and power consumption on existing room air conditioning
- Divert and recycle waste hot air providing free heating to other rooms
- Helps prevent hardware and software failures
- Helps prevent any unnecessary downtime
- Access to rear of cabinet and door opening is not affected when the ducting kit is utilised
- Retrofittable to the 24U and 42U edge-3 cabinet
- Can be directed to exhaust through wall, window or ceiling plenum

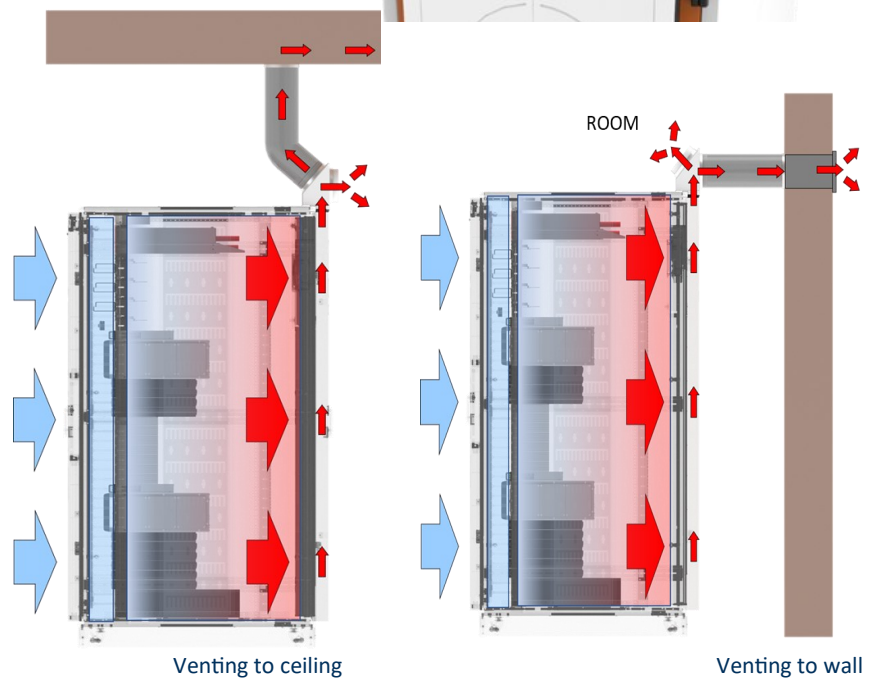

Cisco side venting kit

Side venting kit for active IT equipment which cools from side to side such as Cisco switch gear etc.

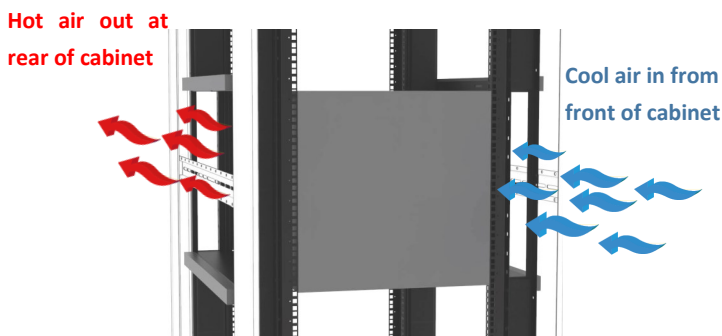

Side venting equipment—Cisco server

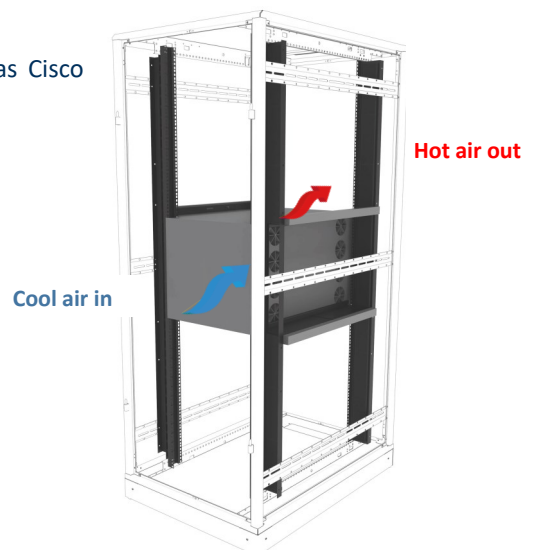

Modular side venting kit fitted to frame for illustration

Extra depth server extension kit

To accommodate greater depth IT equipment such as some of the latest high power servers

The extension kit enables these to be housed in the *EDGE-3* by giving an additional 300mm depth to accommodate this type of specialist, deeper equipment.

The extension kit is fully retrofittable and will not adversely affect the performance of the cabinet.



Intelligent power

A full suite of fully specified intelligent power strips in a variety of entry levels



Security

A full electronic access and security system, key pad, bio metric etc.



Uninterruptible power supplies

Protection for hardware from unexpected power disruption



Further Documentation

For additional information, please refer to the below. Available through your USystems representative, or our central inquires line at sales@usystems.com

| | |
|-----------------------------------|---|
| Complete Product Range | Available at www.usystems.com |
| Operations and Maintenance Manual | Please contact sales@usystems.com |
| Troubleshooting Guide | Please contact sales@usystems.com |
| Product Datasheet | Available at www.usystems.com |



EDGE MDCs



We engineer for a sustainable tomorrow.

www.usystems.com

Europe

Systems House, 235 Ampthill Road
Bedford, MK42 9QG, UK

Tel: +44 (0) 1234 761 720

Middle East

Unit 706B, Al Shamsi Building, Al
Nahda 1, Dubai, United Arab
Emirates

Tel: 97 155 998 1198

North America

10 Glenlake Parkway, Suite 130
Atlanta, Georgia, 30328, USA

Tel: 404 334 3607

India

207, 2nd Floor Regus Supreme
(Jayanagar), 44/1, 16th Cross,
Jayanagar, 7th block (west), KR Road,
Bangalore - 560070, India

Tel: 080 6185 2022